

INNOVA STAINLESS STEEL TOUCH (INP-C)

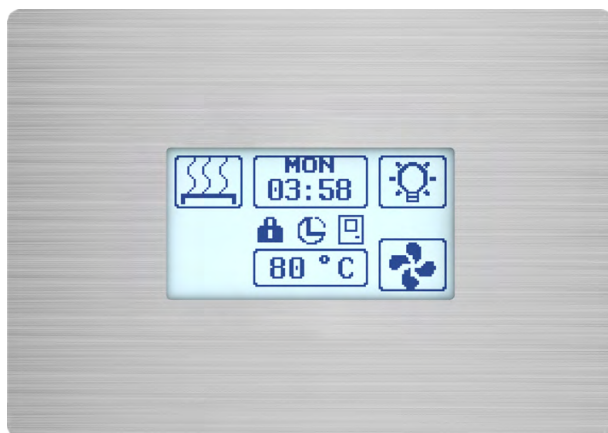

**Congratulations on your purchase of Innova Control Unit!
Please read the manual carefully before using the control.**

Not for use in the USA, Canada and Mexico.

ENGLISH

1. Introduction of the Innova Controls 3
 1.1 Precautions..... 3

2. Direction of Use 4
 2.1 Turning on the Control Unit 4
 2.1.1 Cabin Light 5
 2.2 Switching the Heater or Steamer On 6
 2.2.1 Temperature..... 7
 2.2.2 Relative Humidity..... 7
 2.2.3 Session Time 8
 2.2.4 Fan 8
 2.2.5 Sauna Session..... 8
 2.2.6 Steamer Session..... 8
 2.3 Pre-run Timer 9
 2.3.1 Pre-run Timer for Domestic Saunas..... 9
 2.3.2 Pre-run Timer for Public Sauna with Weekly Timer 11
 2.4 Changing the Setting 13
 2.5 Other Innova Control Feature 14
 2.5.1 Key Lock..... 14
 2.6 Combi Features..... 15
 2.6.1 Steamer 15
 2.6.2 Humidity & Temperature in Sauna 15
 2.6.3 Cabin Drying 15
 2.6.4 Technical Diagram..... 16

3. Remote and Alarm Connections 18
 3.1 Water Refill 19

4. Assembly and Installation.....20
 4.1 Control Unit to Heater Connection Diagram.....20
 4.2 Power Controller 21
 4.3 Contactor Unit..... 21
 4.4 Sensors..... 22
 4.4.1 Sensor Location with Heaters Mounted on the Wall..... 22
 4.4.2 Sensor Location with Heaters Mounted on the Floor..... 23
 4.5 Maximum Session Time 23
 4.6 Door Sensor (Optional) 24
 4.7 Fan (Optional) 24
 4.8 Dimmer (Optional) 24
 4.9 Installation for Separate Control Panel..... 25
 4.10 The Control Unit Main Switch..... 26

5. Troubleshooting 27

6. Symbol Reference..... 28

Congratulations on your purchase of Innova Control Unit!

Innova Control Unit is developed to enhance your sauna bathing with a variety of features. It can adjust temperature, humidity, ventilation and light option in your sauna. The Innova Control Units are available on a separate or built-in mounting on the Power Controller Board.

The following information provides you with instructions on adjusting the settings of the control unit. Please, read this instruction manual carefully before using the control unit. Familiarization of the key functions will give you a more enjoyable sauna experience.



1.1 Precautions

1. Only a qualified electrician is allowed to make the electrical connections and repairs on the unit. Use original parts only.
2. Disconnect the Power Controller and the Contactor Unit from the electrical circuit before installation, opening the lid of the power controller or contactor unit and repair.
3. Check power supply rating before installation.
4. Check the correct location of the sensor in the installation section of the manual. It is very important to place the temperature sensor correctly as its closeness to the air ventilation cools down the sensor and may lead to overheating.
5. The control unit can be operated on a room temperature 0-40°C. Do not install the control unit inside the sauna room!
6. Do not pour water in the control unit or clean it with wet cloth. For cleaning purposes, use a cleaning cloth that has been only slightly moistened with a mild soapy solvent (dish detergent).

2. DIRECTION OF USE



2.1 Turning on the Control Unit

When turning on the power controller, Innova Touch will turn on and automatically go to off-mode.



Then, the control unit will go to OFF mode, where you can switch on the heater, use lights, activate key lock and go to assy-mode

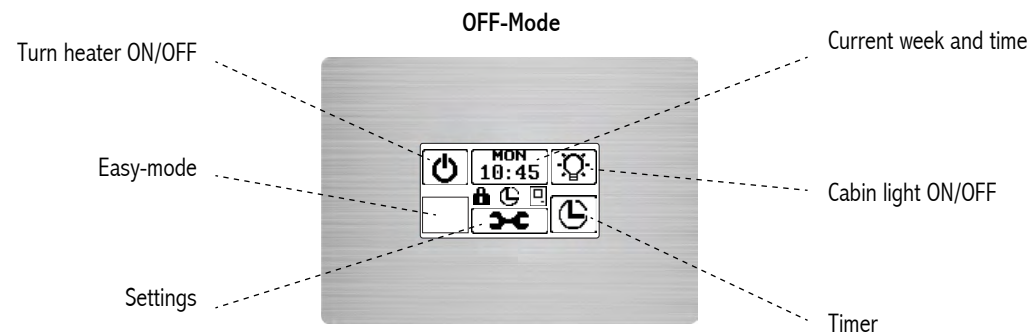

NOTE Soft touch display. Too much pressure on the screen may cause damage.

In easy mode some of the buttons are hidden. This feature makes Innova easy and fast to use. Long press the hidden easy-button for 10 seconds to activate easy-mode. In easy-mode it is still possible to use the heater, steamer and adjust cabin light.

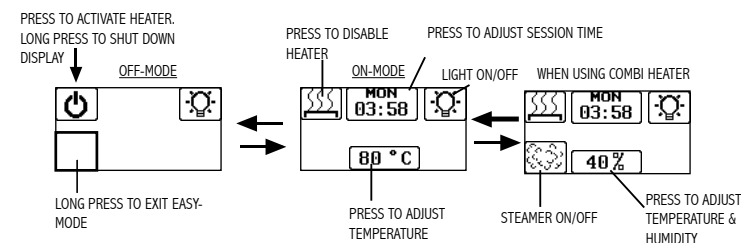

Switch OFF

The backlight is turned off after 1 minute of inactivity (no key pressed). after 60 minutes of inactivity (no key pressed) and no pending drain, autofan or active autosession display will turn off.

2.1.1 Cabin Light

Cabin lights can be switched on and off by pressing Cabin Light button even when the control unit is in OFF-state. If dimmer feature is available, you can adjust the brightness with arrow buttons. Confirm any changes by pressing OK-button. If no buttons are pressed in five seconds, any changes will be saved and display returns to it's previous state.

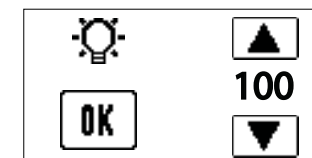



2.2 Switching the Heater or Steamer *ON

OFF-Mode

Heater ON

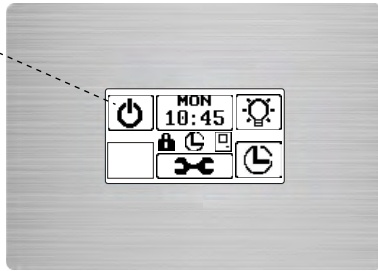

* not available in all models

ON-Mode

Steamer* on/off

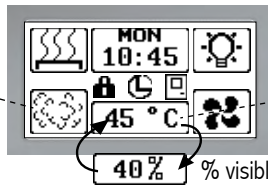

Temperature and humidity

40% % visible when using H/R sensor.

1. The heater can be switched on by pressing the heater on icon in OFF mode.
2. Alternatively, the user can switch the steamer on by pressing the steamer icon in the ON mode. Those features that have animated logo are currently active. If you want to turn on/off the steamer*, press the steamer icon.
3. Heater and steamer are turned off by pressing the heater-icon. After this Innova will automatically go to off-mode.

WARNING



Always check that there is no combustibile material, like towels, above the heater, nor inside the safety distances, before switching the heater on! The safety distances are stated in the heater manual.

Up and Down Arrow Keys



Once the heater has been switched on, ON mode will be displayed. The user can change the settings simply by pressing the relevant icon on the display and using the up and down arrows.

The Up and Down Arrow Keys are repetitive. This means that holding down the up or down key will cause the set-point value to in- or decrease with a specific rate. This rate also increases when holding the key for a longer time.

ON-Mode

Heater ON/OFF

Session Time

Steam ON/OFF

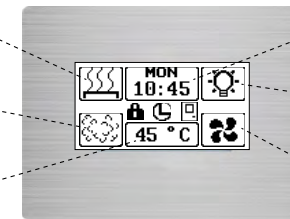

Light ON/OFF

Room Temperature
Relative Humidity

Fan ON/OFF

45 °C

2.2.1 Temperature

Press the temperature icon to change the temperature with up and down arrow keys. After setting the preferred temperature, user can go back to the previous state with saved settings by pressing the OK button.

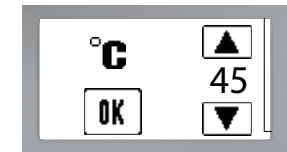

Temperature Unit = Celcius

If no keys are pressed within 5 seconds after pressing the temperature button, the changes are saved and innova will go back to previous state.

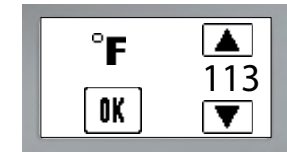

Temperature Unit = Fahrenheit

2.2.2 Relative Humidity RH%

To change the relative humidity (not in all models), press the humidity icon and use the up and down arrow keys to change it. After setting the preferred humidity, user can go back to the previous menu with saved settings by pressing the enter button.

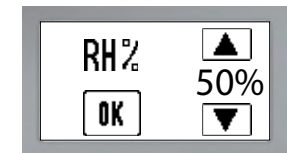

If no keys are pressed within 5 seconds after pressing the temperature button, the changes are saved and innova will go back to previous state.

2.2.3 Session Time

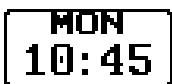

Press the session time icon to change it with up and down arrow keys. After setting the preferred session time, user can go back to the previous menu with saved settings by pressing the enter button.

If no keys are pressed within 5 seconds after pressing the session time button, the changes will be saved innova returns back to previous state.

If the session time is changed within the first 5 minutes after starting, the set values are saved as a start value for the next session.

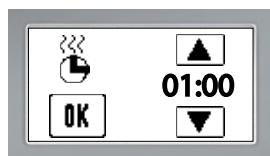

When the session time expires, a high tone buzzer notifies the user. Then the control unit goes to off mode or cabin drying (only with steamer).

The session can be finished earlier than originally set by pressing the heater on/off button.

The control unit goes to off mode or cabin drying (only with steamer).

If the user attempts to put an invalid input, short, low tone buzzer can be heard to alarm the user.

2.2.4 Fan



Press the fan icon (not in all models), to set the fan speed, in the range of 5% -100%. After setting the preferred speed, user can go back to the previous menu with saved settings by waiting for 5 seconds to automatically return or pressing the OK button to return immediately.

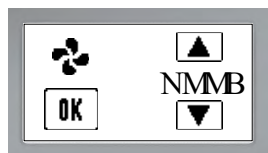

When fan is on, the icon is animated. By pressing the fan icon again the fan will stop and the animation of the icon stops.

2.2.5 Sauna Session



When the heater is on, the sauna icon is animated. You can turn off the heater by pressing the sauna icon. After pressing innova will go to off mode/cabin dry mode.

2.2.6 Steamer Session (available in combi models)



When steam session is activated, the steamer symbol is animated. If user presses again the animated steamer

symbol, steamer is turned off and the session will continue as a normal sauna session.



2.3 Pre-run Timer

OFF-Mode

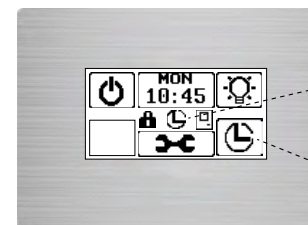

When small timer icon appears, there is 1 or more active timer settings at the moment.

Timer



The Innova Touch control unit has a weekly timer that can be programmed for every day of the week.

This feature is only available for public saunas, used in condominiums, hotels or other similar places.

2.3.1 Pre-run Timer for Domestic Saunas

For domestic sauna use, the weekly timer is not allowed*). Only one pre-run timer setting can be made at a time. The pre-run time is limited to a maximum of 6 hours for domestic saunas.

*) IEC 60335-2-53

After pressing the timer icon in the OFF-mode, the following screens will be shown displaying existing pre-run settings.

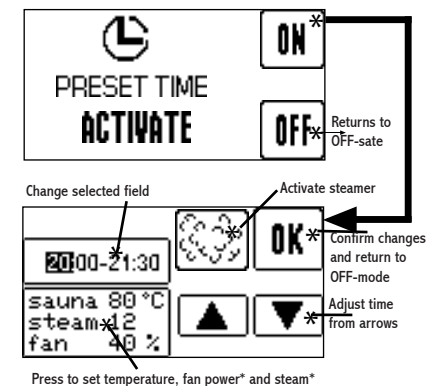

Press timer icon to enter the preset timer settings.



To change any preset timer settings, move on to next screen by pressing ON-button. Turn off any timer settings by pressing OFF-button and return to OFF-mode.

NOTE

By Default, the Pre-run Timer is set for Domestic Sauna use.

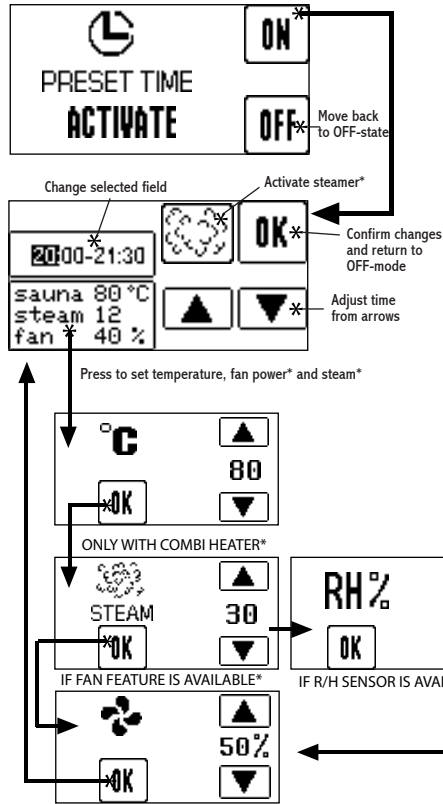

By pressing OFF-button you can cancel all active timers and go back to OFF-mode. By pressing ON-button you will move on to changing timer settings. Cancel all active timers by pressing the OFF button.

You can activate steamer by pressing the steamer icon. By pressing time you can move the cursor from hours to minutes and change the time value from arrow buttons. To adjust temperature, steamer* or fan*, press the "sauna" text. Adjust values as preferred and move to next screen by pressing OK or waiting 5 seconds. Confirm changes and save the timer by pressing OK and return to OFF-mode.

*Available settings may vary between models

When adjustments to time and settings are done, save timer by pressing OK button.

If small timer icon is visible, it means that there is an active timer setting at the moment.

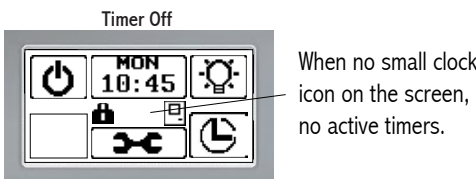
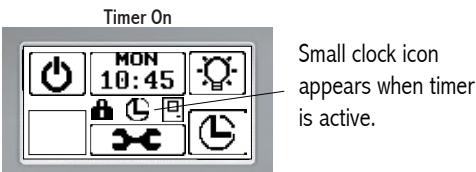
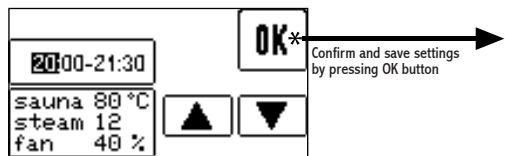

2.3.2 Pre-run timer for public saunas with weekly timer

NOTE
When jumper is placed in the 12 hour setting, 6 hours OFF time is required between two consecutive sessions when using Pre-run timer function.

OFF-Mode

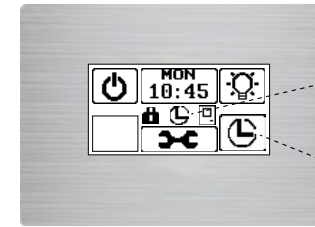

When small timer icon appears, there is 1 or more active timer settings at the moment.

Timer

Press timer icon to set timers.

Then you can continue to adjust timer settings by pressing OK. If you want to return back to OFF mode and turn off all timers press OFF button.

Weekly timer is only available if max session time setting has adjusted to be 12 hours or more (page 22). If max on time has been set to 12 hours, automatic restart can only happen after 6 hours of the previous automatic start (IEC 6-335-253).

NOTE
Before setting any preset timers, make sure that current day and time are correct from the settings menu (2.5).

After pressing ON button you will go to adjust timer settings. Days that have "✓" indicator have an active timer. By long pressing that days icon for 3 seconds you can cancel all active timers from that particular day. By pressing on any of the week days you can adjust the timer settings of that day.

Press the timers to change selected field. Timers that have "✓" indicator are currently active. Activate/inactivate timer by pressing the ✓-button

Press the hammer icon to change settings of the selected timer. By pressing ESC button you can cancel any changes and return to OFF mode.

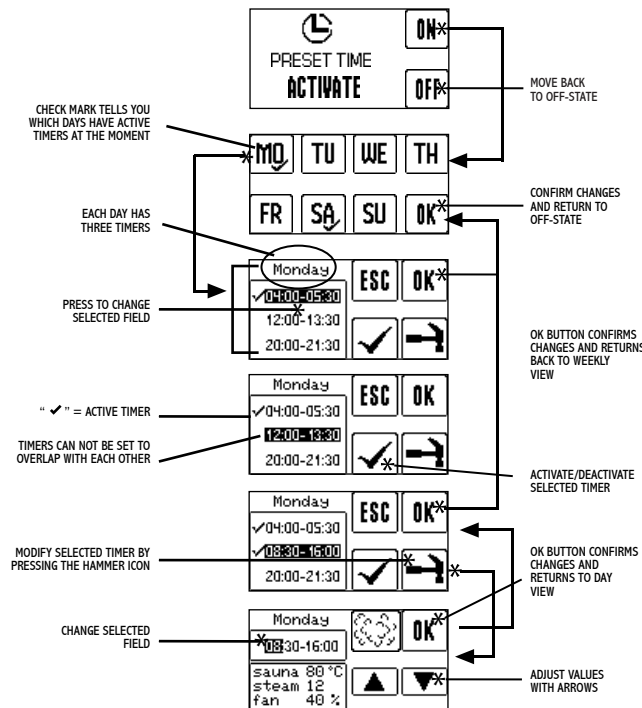

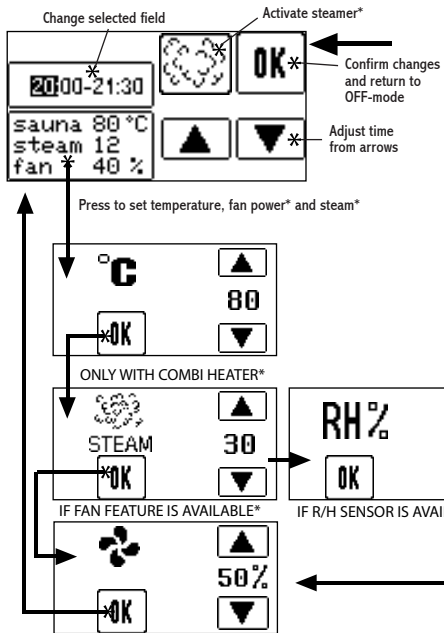

You can activate steamer by pressing the steamer icon. By pressing time you can move the cursor from hours to minutes and change the time value from arrow buttons. To adjust temperature, steamer* or fan*, press the "sauna" text. Adjust values as preferred and move to next screen by pressing OK or waiting 5 seconds. Confirm changes and save the timer by pressing OK and return to OFF-mode.

*Available settings may vary between models.

After changing setting you can confirm changes by pressing OK button and return to daily view --> weekly view --> Off mode.

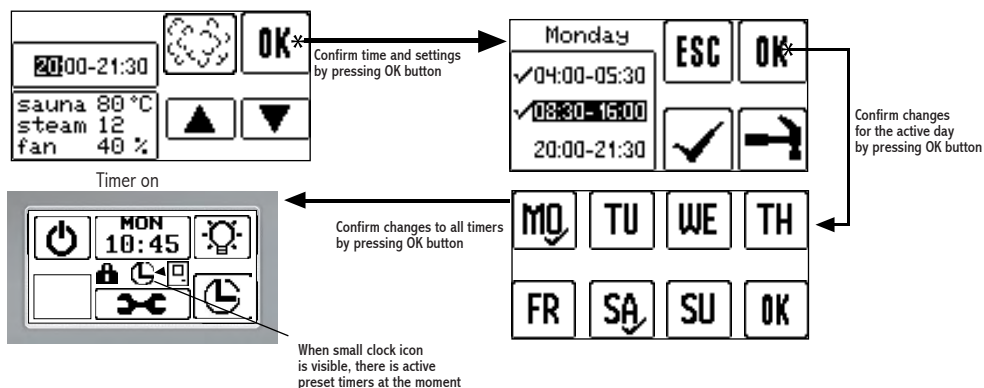

2.4 Changing the settings

From OFF mode you can access to settings, timer, Easy mode and turn on lights and heater

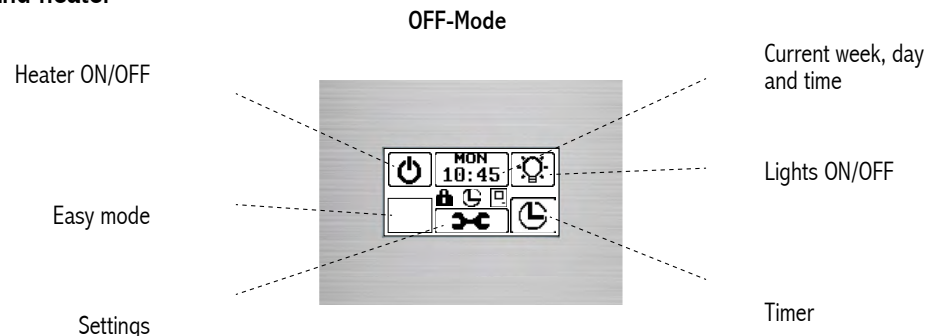

Long press settings button for 5 seconds to access settings menu. In settings menu you can navigate between settings by using arrows Right and Left, and change the displayed setting by using arrows Up and Down unless mentioned otherwise below. After changes are done confirm them by navigating to Save&Exit screen and press SAVE. If you want to discard all changes press ESC.

-
-
-
-
-
-
-

Pressing the weekday, hours or minutes button you can set the correct time and day. In case of electricity blackout the day and time keep running and there is no need to set them again.

Check what is the power of your heater and adjust the value on screen accordingly in kilowatts.

When auto cabin light is activated, the lights will turn on automatically when the heater is turned on. If this function is disabled you can use the cabin light manually.

Auto fan feature is for drying your sauna room after sauna session. You can adjust the desired exhaust fan time. Fan will turn on automatically after sauna session has ended.

You can adjust the LCD contrast.

Active blackout memory restores control to its previous state before power failure. For example, if heater was on before power failure, the heater will automatically continue from the previous state.

You may set the temperature scale either Celsius or Fahrenheit.

8.  Software version has two parts, Interface Software Version and the Controller Board Version.

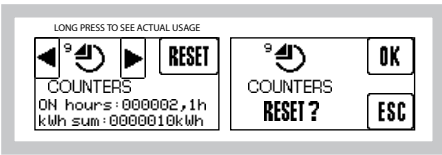

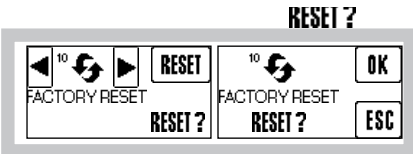
9.  Counters displays the usage of time and kilowatt of the heater/steamer. This info is necessary to evaluate need of preventive maintenance and compute electricity consumption. Pressing reset button will reset both counters, previous data can't be retrieved. Long pressing reset button for 10 seconds to see actual usage. Actual usage counter can not be reseted.

10.  Reset all settings back to factory settings by pressing reset button. Confirm resetting by pressing OK button. Restoring factory settings won't reset kWh and ON hours counters.

Only in Combi heater

11.  Set the correct kilowatt value of the Combi steamer to the control (see kilowatt information on your steamer). Change the value with arrows.

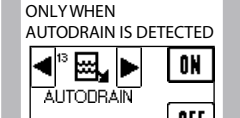
12.  Cabin dry setting will help you to dry up your sauna room after a steam session. After steam session the display will automatically start cabin dry. During cabin dry the set value for room temperature is 70°C and fan power 100%. Cabin drying takes 30 minutes. You can cancel on going drying by pressing ESC button. NOTE: if cabin dry is enabled, max on time for steam session is reduced by 30 minutes if max on time is set to 4, 6 or 12 hours.

13.  When auto drain is enabled, it will automatically drain the water inside the combi tank after use. In case of power interruption, it will continue to drain when detecting high water level in the tank. If there is draining pending, this icon will be shown on the screen: 

14.  Once everything has been set, you may press SAVE to save all the changes, or by pressing ESC to discard all changes.

2.5 Other Innova control feature

2.5.1 Key lock

To lock/unlock screen, press more than 10 seconds the settings icon. Lock will appear on the screen when key lock is activated:  When key lock is activated, you can still turn the heater ON/OFF and use the cabin lights. If any unauthorised actions are made, "KEY LOCK" text will appear on the screen for 5 seconds.

When power controller is turned ON again, the Key Lock will remain either ON or OFF as it was before power controller was turned OFF.

2.6 Combi Features

2.6.1 Steamer

These features for steamer are only applicable with Combi heaters.

2.6.2 Humidity & Temperature in the Sauna

High humidity and high temperature are not allowed simultaneously in the sauna room. When sauna session is switched to steamer session, sensors will check that the temperature or the relative humidity inside the sauna room is not too high.

If the temperature or relative humidity is too high, the steamer will not be activated.

Steamer activation depends on the second sensor, the bench sensor. If it is a temperature sensor only, and the bench temperature in the sauna room is 56°C or more, the steamer cannot be activated. The user can choose the relative time for

the steamer to be on, within 30-100% of the session time.

However, if the second sensor is combined temperature / humidity sensor, the maximum bench temperature for the steamer to activate is 80°C, as long as the relative humidity in the sauna room is not too high. With the combined sensor, the user can choose the relative humidity inside the sauna room.

2.6.3 Cabin Drying

The standard drying time is set for 30 minutes at 70°C. If the fan is connected with the control unit, it will be running at 100%, during the cabin drying. The cabin drying is set to begin 10 minutes after the steamer session. Therefore, the actual drying time is 20 minutes.



If during the steamer session the operation mode is changed to heater only, there will be no drying time at the end of the session. You can abort cabin drying by pressing the ESC button.

2.6.4 Technical Diagram

Fig. 1

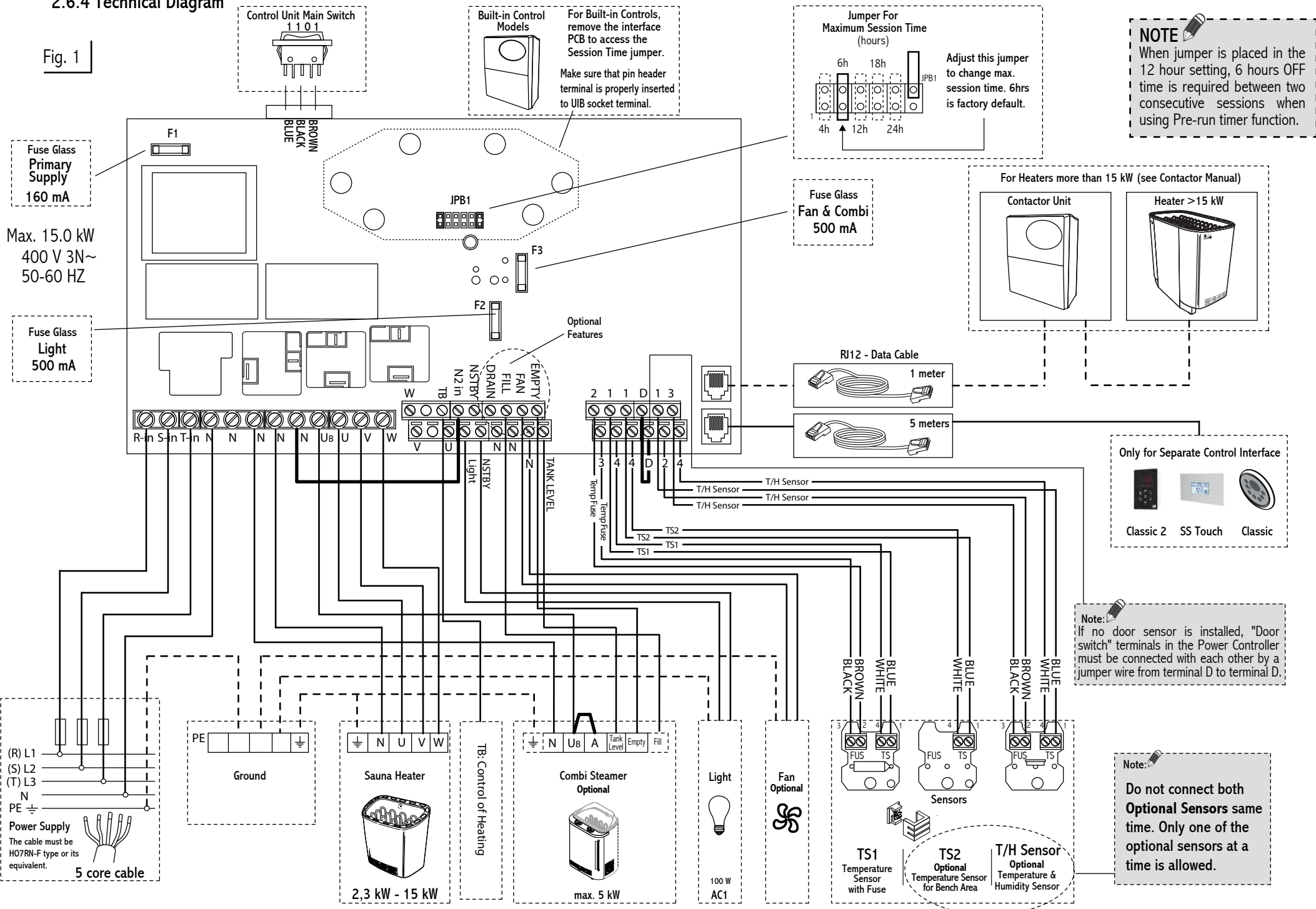

Fuse Glass
Primary Supply
160 mA

Max. 15.0 kW
400 V 3N~
50-60 HZ

Fuse Glass
Light
500 mA

(R) L1
(S) L2
(T) L3
N
PE

Power Supply
The cable must be
HO7RN-F type or its
equivalent.

5 core cable

PE

Ground

N U V W

Sauna Heater

2,3 kW - 15 kW

TB: Control of Heating

N UB A Tank Level Empty Fill

Combi Steamer
Optional

max. 5 kW

Light

100 W
AC1

Fan
Optional

TS1
Temperature
Sensor
with Fuse

TS2
Optional
Temperature Sensor
for Bench Area

T/H Sensor
Optional
Temperature &
Humidity Sensor

Sensors

Note:

If no door sensor is installed, "Door switch" terminals in the Power Controller must be connected with each other by a jumper wire from terminal D to terminal D.

Note:

Do not connect both
Optional Sensors same
time. Only one of the
optional sensors at a
time is allowed.

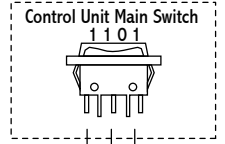

Built-in Control Models

For Built-in Controls, remove the interface PCB to access the Session Time jumper.

Make sure that pin header terminal is properly inserted to UIB socket terminal.

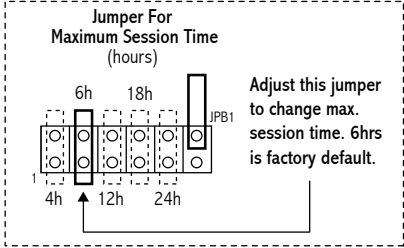

NOTE

When jumper is placed in the 12 hour setting, 6 hours OFF time is required between two consecutive sessions when using Pre-run timer function.

Fuse Glass
Fan & Combi
500 mA

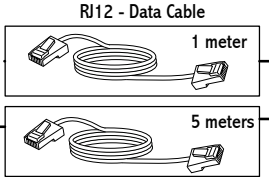
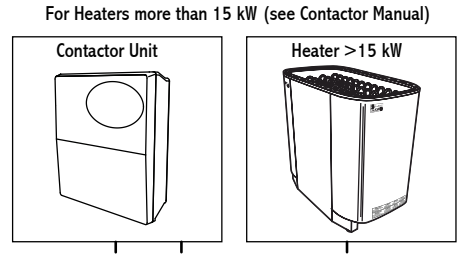

3. REMOTE AND ALARM CONNECTIONS

Stainless Steel Touch Control

(Back of the user's panel)

Insert RJ Cable

REMOTE CONTROL CIRCUIT DIAGRAM

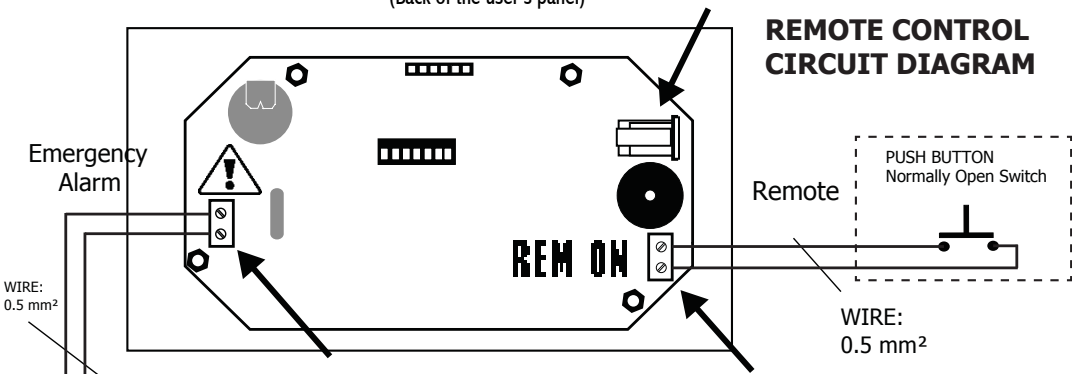

Terminal Block

EMERGENCY ALARM CIRCUIT DIAGRAM

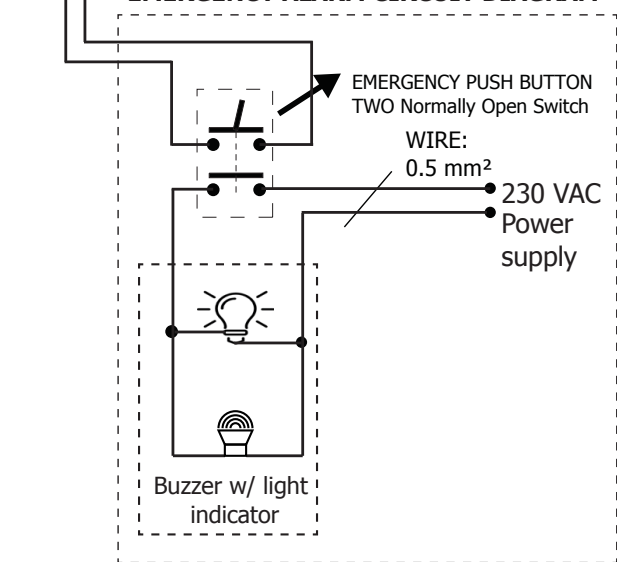

3.1 Water Refill

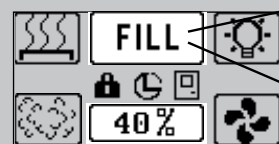

FILL TEXT WILL APPEAR WHEN WATER LEVEL IS LOW.

YOU CAN MUTE THE ALARM BY PRESSING FILL TEXT/FAUCET ICON.

When the water level is low, a low tone interval beep and "Fill" will be displayed to alarm the user.

The steamer will automatically be switched off now, only the heater will be working.

The water tank can be filled manually or automatically (autofill) depending on the steamer model.

Always check that the water supply is open before using the automatic refill Combi heater!

The auto Combi heater has a solenoid valve, which will automatically react to the low level of water. The water inlet will open to fill up the tank and steamer session can be continued without intervention.

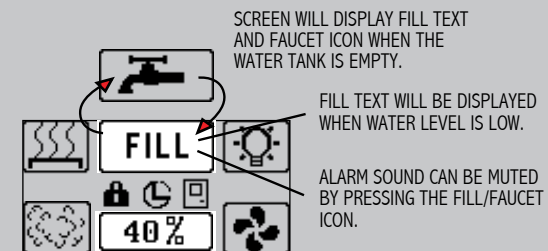

SCREEN WILL DISPLAY FILL TEXT AND FAUCET ICON WHEN THE WATER TANK IS EMPTY.

FILL TEXT WILL BE DISPLAYED WHEN WATER LEVEL IS LOW.

ALARM SOUND CAN BE MUTED BY PRESSING THE FILL/FAUCET ICON.

In the manual fill, the alarm beeps and "Fill" will be displayed as long as the user fills the tank. If the water tank dries, a high tone interval beep and "Dry" display will alarm the user. In the display a faucet icon and "Fill" text will be alternating each second.

4. ASSEMBLY AND INSTALLATION

The Innova Control Unit consists of the Innova Control panel, Power Controller and Sensors. The control panel and Power Controller communicate by using a RJ12 cable.

4.1 Control Unit to Heater Connection Diagram

Fig. 2

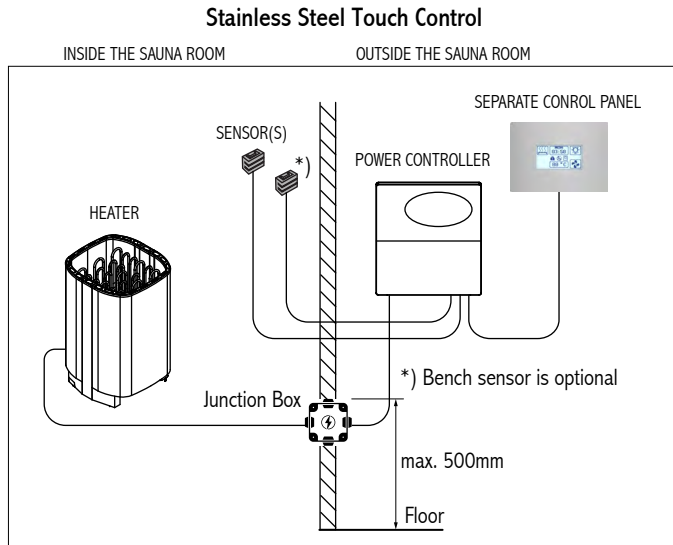

WARNING

If door sensor is used and sauna door is opened during pre run time, all preset timers are inactivated. While door is open, door icon is displayed.

4.2 Power Controller

The power controller or the separate control panel must not be located inside the sauna room or in places where temperature can exceed +40°C. It is protected against water splashes, however it should not get in contact with water. Mount the controller board on a dry location, outside the sauna room.

Install the Power Controller Board on the wall in vertical direction only and at least 30cm from the ceiling (refer to Fig.3).

Fig. 3

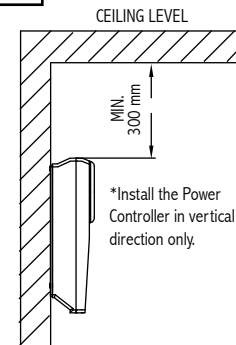

Heater Connection

The heater is connected to the electrical network semi-stationarily with a HO7RN-F rubber cable or its equivalent. The use of PVC-insulated cable as a connecting cable is prohibited due to thermal embrittlement. The maximum distance of the junction box from the floor is 500 mm, measured from the upper corner of the box (refer to Fig.2).

Fig. 4

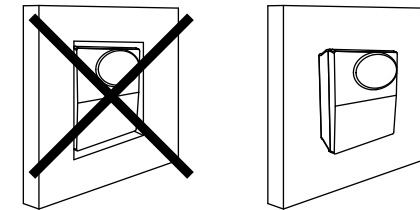

WARNING

Do not embed the control unit into the wall, because it may lead to overheating of the unit and cause damage!

4.3 Contactor Unit

If the heater used is more than 15kW, an additional contactor is needed. The contactor unit is linked to the main Power Controller Board with a RJ12 cable (Fig.5).

Follow the instructions that are supplied together with the contactor unit.

Fig. 5

Installation of separate Control Panel and Power Controller with Contactor Unit

Stainless Steel Touch Control

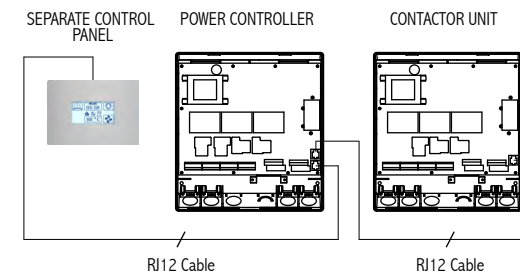

4.4 Sensors

One or two sensors can be connected to the Power Controller. The first sensor measures the temperature, it is the sensor with temperature fuse and thermistor.

The second sensor, the optional bench sensor, is a temperature sensor or combined temperature humidity sensor. The combined sensor is capable of measuring the humidity as well as the temperature.

With two sensors it is possible to receive more accurate measurements from the sauna room.

If the heater is mounted on the wall or floor standing less than 200mm from the wall, the first temperature sensor needs to be mounted on the wall above the heater. Place the sensor 150mm from the ceiling (Fig. 6 & 7).

4.4.1 Sensor location with heaters mounted on the wall

Fig. 6

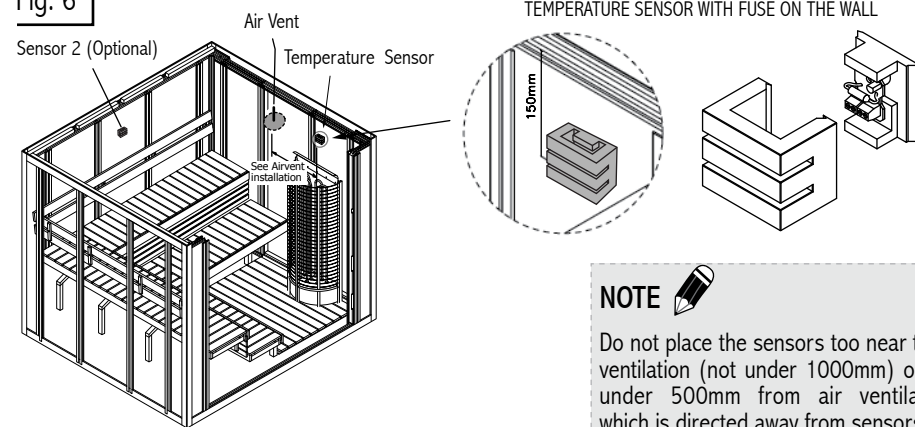
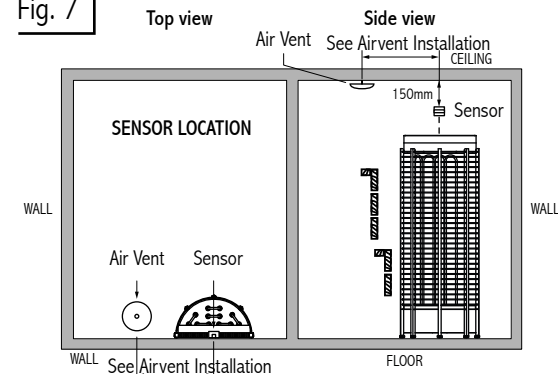

Fig. 7



However, if the heater is more than 200mm from the wall, place the sensor to the ceiling, over the heater, as shown in the figure 8 & 9.

The optional second sensor should be mounted on the wall, opposite to the heater, minimum 30cm from the ceiling and minimum 130cm from the floor (fig 6 & 8). It is designed to measure the bench temperature, so ideally place it close to the shoulder height of the sauna goers.

Do not place the sensors near the air ventilation. The closeness of the air vent cools down the sensor. Thus, an incorrect temperature is displayed and the heater may overheat (Fig.9).

4.4.2 Sensor location with heaters mounted on the floor more than 200mm from the wall

Fig. 8

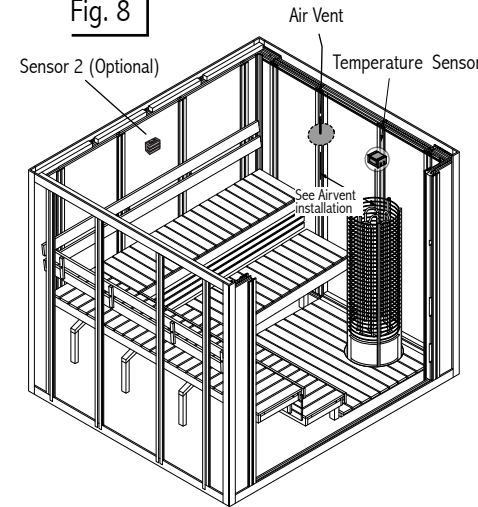
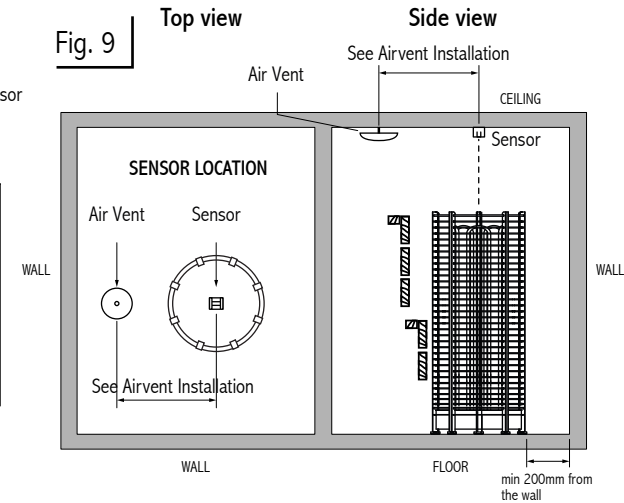

Fig. 9



4.5 Maximum Session Time

The maximum sauna session time depends on the purpose of the sauna. For domestic use, the total on-time of the sauna is limited to 6 hours. *) It includes pre-run time and the session time. The factory setting for the control unit is 6 hours.

For condominiums, hotels and similar locations, the operating period of the sauna heater is limited to 12 hours, including the pre-run time and the session time.

For public sauna, the operating period of the sauna heater can be either 18 or 24 hours. Please note, if the jumper is set to 24 hours, and it will be on constantly. It needs to be continuously monitored.

*) IEC 60335-2-53

NOTE

When jumper is placed in the 12 hour setting, 6 hours OFF time is required between two consecutive sessions when using Pre-run timer function.

The maximum heater on-time is set by the jumpers on SCB1 in the power controller, Figure 2 and 11. Jumpers 3, 4 and 5 are meant only for public sauna rooms. Only a qualified electrician can change the settings. The standards and regulations of the country where the control unit is installed must be followed when setting the jumpers. When no jumpers are placed, the default time is 6 hours. See the Figure 10.

NOTE

Do not place the sensors too near to air ventilation (not under 1000mm) or not under 500mm from air ventilation, which is directed away from sensors.

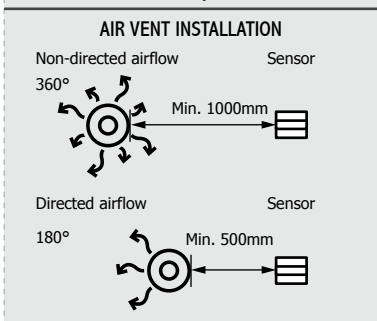

NOTE

If you need to change the settings in the power controller with built-in panel, removing the control panel helps.

Fig. 11

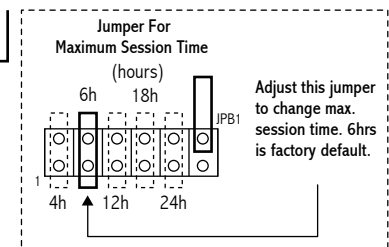

Fig. 10

Sauna Type	Domestic sauna		Hotels, Condominiums		Public sauna	
Jumper	1	2	3		4	5
Max. time	4h	6h	12h		18h	24h
Max. pre-run time	2h - steam	4h - steam	99h		3h - steam	5h - steam

4.6 Door Sensor (Optional)

In other than household use, it is recommended to install door sensor. The door sensor disables all pre-run operations if the door is opened while the pre-run countdown is active.

The door sensor also ensures that the door is not open for long periods of time when the heater is on. If the heater is on and the door is open for more than 15 minutes, an alarm and "DOOR" will be displayed to warn the user. The heater will be switched off automatically.

NOTE

If no door sensor is installed, "Door switch" terminals in the Power Controller must be connected with each other by a jumper wire from terminal D to terminal D. (Figure 1)

4.7 Fan (Optional)

The fan function can only be activated if the fan feature is present on the control unit. Ensure that the fan motor to be controlled is either shaded pole or permanent split capacitor motor. The maximum power is 100W with 230 VAC.

4.8 Dimmer (Optional)

It is possible to use any suitable lamp of your choice in the sauna room. However, if the dimmer feature is present on the control unit and wished to be used, only incandescent lamp is suitable.

4.9 Installation for Separate Control Panel (See Illustration)

1. Mount the Separate control panel casing outside the sauna room, in preferred, secure area on a room temperature.
2. Cut the wall section according to the specifications.
3. Connect the RJ12 cable provided from the control panel to the Power Controller.
4. Insert the casing on the cut section.
5. Screw the Control panel to the wall on the holes provided.
6. Snap the top cover of the panel to its place.

NOTE

Check if your Innova control has oval shaped or rectangular shaped back cover before making the hole for the separate control panel.

Stainless Steel Touch Control

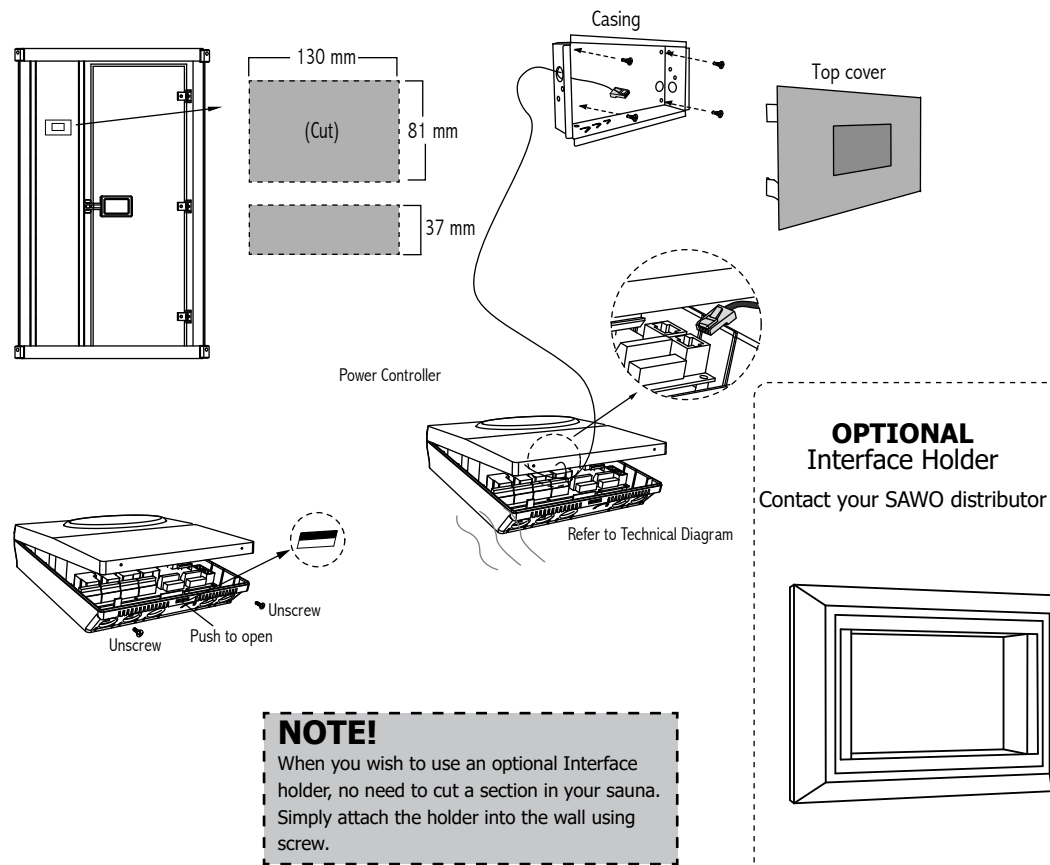

4.10 The Control Unit Main Switch

The control unit switch can be found on the top end of the unit. Using this switch, you can isolate the electronics from the mains power supply.

In order to put the unit into operation, switch to the first position (switch position I). In this switch position all control unit's functions work normally.

In case of breakdown, press the control unit switch on the left part of the rocker to the middle position (switch position 0). The unit is now completely switched off.

In order to switch on the light in the sauna when the unit is switched off, press on the left part of the rocker to the second position (switch position II).

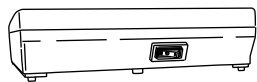

II 0 I

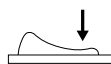

I = UNIT ON

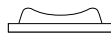

0 = OFF

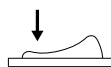

II = LIGHT ON

5. TROUBLESHOOTING

If an error occurs, the heater will be switched off. There will be a high tone warning beep for 2 seconds. Text "ERROR" will be blinking in the display with the error description.



See more details on the table below.

WARNING

Please note, only a qualified electrician or maintenance personnel is allowed to make the service operations and repairs!

Table 2

Code	Problem	Solution
E1	Temperature sensor 1 is not connected.	Check the wire between the sensor and the control unit. If there is no problem with the wires and they are correctly installed, check the sensor.
E2	Temperature sensor 1 is short circuit.	If no reason for the problem can be found, contact the retailer.
E3	Temperature fuse is defective.	Check the thermal fuse if it's not overheated & has continuity. Check the wire between the sensor and the control unit. The reason for it needs to be discovered before using the sauna again. A new sensor is needed. If no reason for the problem can be found, contact the retailer.
E4	Temperature sensor 2 is not connected.	Check the wire between the bench sensor and the control unit. If there is no problem with the wires and they are correctly installed, check the sensor. The heater can still be used with the sensor 1 only, but 2 sensors are needed for the steamer. If a new sensor is needed or no reason for the problem can be found, contact the retailer.
E5	Temperature sensor 2 is short circuit.	
E6	Combined Temperature / Humidity sensor is defective.	
E7	Communication failure.	Check the RJ12 cable. If the area where the cable is located has many other cables, it can cause interference problems. If built-in model is used, remove the control panel. Wipe the pin header contact to remove any dirt. Assemble back the control panel in correct position and make sure the six pin header connectors are properly inserted to the socket. If no reason for the problem can be found, contact the retailer.
E8	Temperature is greater than the maximum temperature.	If this happens contact qualified electrician or maintenance personnel before using the sauna again.

6. SYMBOL REFERENCE

	Short press Long press and no pending drain, autofan or active autosession	To switch on – Manual Sauna session Switch display off
	Date and time	Change date and time from settings
	Short press Short press (if dimmer feature available)	Light on/off set Cabine Light brightness
	Press > 10 seconds	Activate EasyMode
	5 sec press 10 sec press	Go to settings Activate key lock
	If auto fan active	Icon animated
	When auto fan is not active	Change timer settings
	Key lock activated	
	Timer is active	Icon visible if there are any active timer settings
	Sauna door is open	If door open and pending for auto drain, icons will blink on the screen with 3 sec interwall
	Pending for steamer auto drain	



















ON-mode







	Short press	Sauna/steam session off
Icon animated if feature active		
	Remote control on	
	Session time	Press to change session time
	Combi heater's water tank needs to refill	Beeping sound will stop when icon is pressed
	Combi heater's water tank is empty	Beeping sound will stop when icon is pressed
	Short press	Light on/off
Icon animated if feature active		
	Short press (if dimmer feature available)	set Cabine Light brightness
Icon animated if feature active		
	Short press	Steamer on
	Short press	Adjust temperature, relative humidity and steamer. Features are depending of heater model and sensor types.
	Short press	Fan on/off
Icon animated if feature active		
		Set fan speed

Buttons

ANIMATED	Heater ON 1		Selector UP
ANIMATED	Steam ON 1		Selector DOWN
ANIMATED	Light 1 / Light OFF		Selector LEFT
ANIMATED	Fan 1 / Fan OFF		Selector RIGHT
	Day & Session Time		ON
	Session Time		OFF
	Room Temperature		Celsius
	Humidity		Fahrenheit
	Steam Strength		Preset Day
	ON/OFF Button		Preset Selected Day
	Settings Menu		Reset
	Save		Time Setting
	Confirm OK		Time Group Activate
	Escape		

Indicators

-  Key Lock
-  Preset time activated
-  Door Lock
-  Preset Time
- PRESET TIME**
- ACTIVATE** Activate
-  Day and Time
- DAY / TIME**
-  Day
-  Hours
-  Minutes
-  Kilowatt Indicator
- KW-VALUE**
-  Steamer Kilowatt Indicator
- STEAM KW-VALUE**
-  Auto Light ON
- AUTO**
-  Auto Fan
- AUTO**
-  LCD Contrast
- LCD CONTRAST**
-  Blackout Memory
- BLACKOUT MEMORY**
-  Temperature Unit
- TEMPERATURE SCALE**
-  Software Version Info
- SW-VERSION**
-  Usage Counter
- COUNTERS**
-  Preset timer active
-  Factory Reset
- FACTORY RESET**

-  Autodrain
- AUTODRAIN**
-  Save and Exit
- SAVE & EXIT**
-  Steam Generator is remotely controlled
- MON REM ON**
-  Control Alarm
-  Cabin Dry
- CABIN DRYING**
-  Low Water Level Combi Tank (Alternate)
- FILL** Low Water Level Combi Tank
-  Cabin Drying Time Counter
- DRYING 09:55**
-  Draining
- DRAINING**
- 09:55** Drain Time Counter

E1 ERROR	Error 1	Temperature sensor 1 not connected.
E2 ERROR	Error 2	Temperature sensor 1 short circuit.
E3 ERROR	Error 3	Temperature fuse has blown.
E4 ERROR	Error 4	Temperature sensor 2 is not connected.
E5 ERROR	Error 5	Temperature sensor 2 short circuit.
E6 ERROR	Error 6	Combined Temp/Hum sensor is defective.
E7 ERROR	Error 7	Communication Failure.
E8 ERROR	Error 8	Temperature is greater than maximum temperature.

Description	Power Rating	Remarks
Control		
Rated Power 3 Phases	15kW AC1 (3 x 5kW)	
Rated Voltage 3 Phases	400V 3N~	
Rated Power Single Phase	9kW AC1	
Rated Voltage Single Phase	230V 1N~	
Frequency	50/60Hz	
Switching capacity per phase	21A	
Sauna temperature range	40-110°C	
Maximum session time (preset)	4,6, 12, 18, 24h	Restrictions apply according to IEC/EN 60335-2-53
Dimensions		
User Interface (Stainless Steel)	(D) 40 mm (W)147mm (H)104mm	
User Interface (OVAL)	(L) 180mm (W) 105mm (H) 31mm	
Power Controller	(W) 265 x (H) 245 x (D) 75	
Weight		
User Interface (Stainless Steel)	390g	
User Interface (Oval)	120g	
Power Controller	1500g	
Sensor		
Temperature Sensor with fuse		
Bench Sensors		
Bench Temperature Sensor		Optional
Bench Combined Temperature - Humidity Sensor		Optional

Description	Power Rating	Remarks
Steamer		
Rated Power 3 Phases	5kW AC1	
Rated Power Single Phase	3kW AC1	
Rated Voltage	230V 1N~	
Switching capacity	21A (3 Phases), 13A (1 Phase)	
Maximum sauna temperature for steamer operation	80°C or *55°C * Depending on the type of Sensor 2.	
Automatic water filling		Optional
Automatic drain valve		Optional
Cabin Light		
Rating	230V 1N~, 100W AC1	Min 20W, max 100W. Only resistive load or dimmable (phase control compatible) light bulb
		Dimmer optional
Fan		
Rating	230V 1N~, 0.5A	Fan without starting capacitor. Optional (with speed control)
Fuse		
Fuse F1	(160mA) is fuse for electronics	
Fuse F2	(1A slow) is fuse for cabin light,	
Fuse F3	(500mA slow) is fuse for fan and automatic refilling combi .	
Power Extension Unit		
Rated Power 3 Phases	15kW AC1 (3 x 5kW)	Additional Power expansion to maximum of 30kW
Rated Voltage 3 Phases	400V 3N~	
Frequency	50/60Hz	
Switching capacity per phase	21A	

NOTE

Only incandescent light bulbs are allowed to use with Innova sauna controller. Light fixtures using electronic transformers for example LED lights, compact fluorescent lights and other similar lights are not compatible with Innova sauna controller. Damages caused by connecting these non-compatible lights are not covered by warranty.

CE UK CA IPX 4 EAC  T40 

Subject to change without notice.



www.sawo.com | info@sawo.com

INN_SST_ML_En_1224